

Directions

inkjet patent reviews

Introductory Slides, October 2023

Introduction to: Directions



- New developments in existing and emerging inkjet technologies
- Technical schematics and explanations
- Commercial intelligence



We are soon entering our 26th series (2023 patent application publication dates)!

Directions
is produced by i4inkjet

To get in touch please email:

adam@i4inkjet.com

(Managing Director)

mikala@i4inkjet.com

(Business Development Manager, Directions)

Upcoming talks and trade shows 2023

i4inkjet's recent and upcoming 2023 talks & trade shows schedule:



About the founder-director of i4inkjet Ltd.



Dr. Adam Strevens

> 15 years working in the field of industrial inkjet printing technology

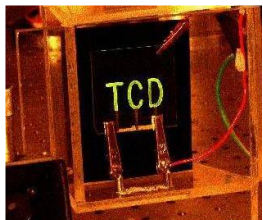

Introduction:

- Adam is currently Director of i4inkjet Ltd. which has two main areas of activity.
 - The first is that i4inkjet Ltd. provides the inkjet industry patent review service and publication called '*Directions*' which is now in its 26th year. Many of the world's largest inkjet companies are currently subscribers to '*Directions*', as are companies with a strategic interest in monitoring inkjet development activities.
 - The second is that i4inkjet offers inkjet consultancy on a wide range of topics under the banner 'Pivotal inkjet resources'. Consultancy aspects include strategic marketing, inkjet training, and inkjet technology reviews and analysis. Data supply agent

- Adam is also a Founder of and Commercial Director at Neatjet Ltd., a new provider of industrial inkjet ink delivery systems



- Before relocating to Ireland Adam spent 14 years in Cambridge, UK. He spent 7 years at Cambridge Display Technology Ltd. (a Sumitomo Chemical Co. subsidiary) where he became group leader of the Device Structure Development team.
 - Directly after the inkjet display technology platform he helped codevelop had been transferred to Sumitomo Chemical in Japan, Adam joined Xaar Plc where he held technology and market analyst roles initially, later becoming strategic marketing manager.
- Prior to working in industry, Adam obtained a degree in advanced materials and a physics doctorate in organic light-emitting diodes, both at Trinity College Dublin (TCD), and still keenly follows developments in these fields, particularly the inkjet-relevant aspects (to the left is a early demo display which was featured in the "The Irish Times" newspaper in 2002.

About i4inkjet Ltd.

i4inkjet Ltd. was set up as a registered company in 2020 and is a digital content provider offering both inkjet vendors and users expert support, through the information provided, for the development of new inkjet products, processes, applications and services. The business operates primarily in the digital printing industry, specializing in inkjet technology, products and markets. 'Pivotal inkjet resources' and 'Directions' are brand names of i4inkjet Ltd.



In April 2020 Adam took on the production and editing of Directions from Mike Willis, who initiated Directions more than 25 years ago. Mike was also a founder of the longstanding series of IMI inkjet conferences, inkjet summer/winter schools and training days, which are well known in the industry.

Some of the Directions production team from Mike's time remains the same, with Dr. Phil Bentley covering inkjet inks. Adam contributes mainly to the inkjet hardware section which Mike used to do. Since Mike retired, we are delighted Tony Cruz-Urbe joined the review team and Tony and Adam share the inkjet printhead reviews with Tony typically doing the Lion's share! In the past few months Dr. Mark Crankshaw has joined the review team and has started to contribute reviews to the hardware sections also. Tony, Phil and Mark have many granted inkjet patents and patent applications bearing their names. Mikala Baines also joined the review team recently and is covers inkjet media, substrates, coatings and 3D printing, with occasion contributions from Adam also.

Finally, Adam has recently broadened the industry corporate news section in Directions to introduce selected inkjet-themed R&D content.

The Directions team



Dr. Adam Strevens - Inkjet printheads, systems & applications, substates - Adam is Owner/Director of [i4inkjet Ltd.](#) and editor and publisher of Directions since 2020. Adam is also Commercial Director at [Neatjet Ltd.](#), an ink delivery system manufacturer. Adam has focused on inkjet technology for over 15 years, having previously worked at Cambridge Display Technology Ltd (part of the Sumitomo Chemical Group) and Xaar Plc. For Directions Adam carries out the initial patent searching and filtering, and reviews the hardware, media, and industry news sections for each issue.

Tony Cruz-Uribe - Inkjet printheads, systems & applications - i4inkjet Ltd. is delighted to inform readers of Directions that Tony Cruz-Uribe (Inkjet Architecture LLC, USA) regularly reviews printhead technology apps. Tony and Adam work jointly on this section, which since mid-2023 Dr. Mark Crankshaw is also contributing reviews to. Tony and Adam have been sharing reviews covering piezo and thermal ink jet printheads mainly, since the start of 2020. Tony has more than 70 inkjet related patents. Tony radiates great enthusiasm for inkjet technology, the physics especially. He most recently worked at Xaar on actuator specification, design and test. His time in the inkjet industry has spanned 40+ years and includes senior roles from the early days of inkjet at Pitney Bowes and DataProducts/Hitachi up to cutting-edge, thin film PIJ at HP. The wealth of experience and deep familiarity with inkjet IP, competitive analysis, and all aspects of printhead development, in particular that of the driver, fluidics, waveforms, and drop ejection, add to the critique provided in his reviews.



Dr. Phil Bentley - Inkjet ink technology - Phil is responsible for ink technology reviews for Directions. He is currently Associate Director at Cambridge Consultants. In the past, Phil was Head of Fluids at Tonejet Limited and was previously CTO at Conductive Inkjet Technology Limited, responsible for a number of multi-disciplinary projects. Phil has been involved with all forms of inkjet technology, has developed a wide range of products for a variety of “difficult” applications and is the inventor of a direct metal printing technology. He graduated from Loughborough University of Technology in 1995 with a BSc in Chemistry with Polymer Science Technology. Phil has a PhD from Sheffield University, on the synthesis and characterisation of liquid crystalline electroluminescent polymers for polarised display applications.

The Directions team



Dr. Mark Crankshaw – Inkjet printheads, systems & applications – Mark has worked almost his entire career in inkjet, and so now has 20+ years' experience in the field, including a number of patents, conference publications and book chapters. Having previously worked at Xaar plc on everything from actuator development and performance to application development, and at Cambridge Display Technology on print process development, he founded Advanced Inkjet Solutions Ltd to provide consultancy and support in all those areas. Mark graduated from the University of Cambridge with a BA in Natural Sciences and continued for his PhD in Materials Science on ceramic reinforcements for metal-matrix composites. Mark recently joined the review team and covers inkjet hardware and imaging topics for Directions along with Tony and Adam.

Mikala Baines – Inkjet substrates, coatings & 3D build materials – Mikala joined the Directions team in 2023 and authors the substrates, coatings and 3D build materials section of Directions, as well as being the key Business Development Manager for Directions. She has 17 years of experience in the printing/coatings industry starting as an R&D formulator of piezo inkjet radiation-curable inks at Fujifilm Specialty Ink Systems, UK. Her focus later moved to specialising in electron beam hardware and applications during her time as Applications Specialist/Business Development Manager at ebeam Technologies, Switzerland. Both roles spanned a variety of applications for inkjet technologies with the larger portion focused on food packaging. Mikala holds a BSc (Hons) in chemistry with The Open University.



i4inkjet Ltd. has two main focus areas

1. Patent-based inkjet technology review publication

Directions
inkjet patent reviews

from

i4inkjet

2. Consultancy covering inkjet technology and markets

pivotal
inkjet resources

from

i4inkjet

Directions

inkjet patent reviews

Content

1. Patent-based inkjet technology review publication

Directions
inkjet patent reviews

from

i4inkjet

>20 years of extensive inkjet patent index generation and inkjet technology reviews in our continuously updated database

...which topics are reviewed?

Topics covered in the patent review section

All kinds of inkjet applications and systems

- Single pass & multi-pass (scanning)
- Intermediate transfer
- Direct-to-object & 3D printers
- Components (dryers, transport, etc.)
- Printhead maintenance
- Others (e.g. specific printed electronics deposition)

Dr. Adam Strevens & Dr. Mark Crankshaw

All kinds of inkjet inks

- Aqueous
- UV-curable & e-beam
- Solvent
- Latex & oil-based
- Conductive & dielectric
- Others (e.g. solder mask)

Dr. Phil Bentley

All kinds of inkjet printheads

- TIJ (thermal inkjet)
- PIJ (piezo inkjet)
- CIJ (continuous inkjet)
- Recirculating & non-recirculating
- High and low viscosity designs
- Others (e.g. electrostatic & large-particle-tolerant designs)

Tony Cruz-Uribe, Dr. Mark Crankshaw & Dr. Adam Strevens

All kinds of inkjet media

- Permeable & impermeable
- Laminates & tiles
- Paper, foils, wood & plastic
- Embellishments
- 3D build materials
- Others (e.g. Glass)

Mikala Baines

Topics covered in the patent review section

Inks

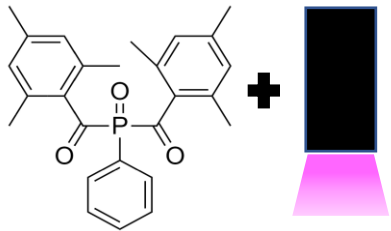

photoinitiator for
UV-curable inks

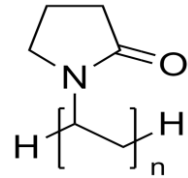

aqueous-soluble
binder for pigments

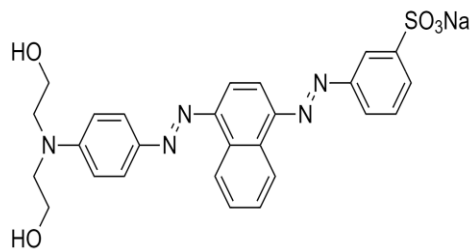

water-soluble dye

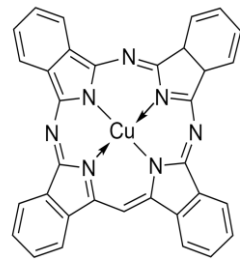

cyan pigment

Media

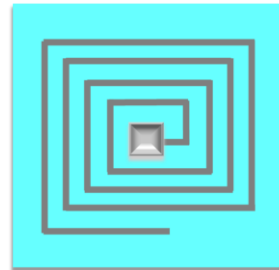

Hardware

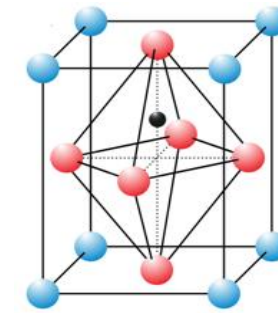

$$T < T_c$$

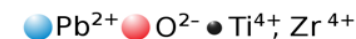

Piezo inkjet

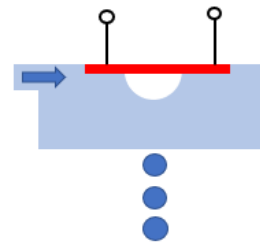
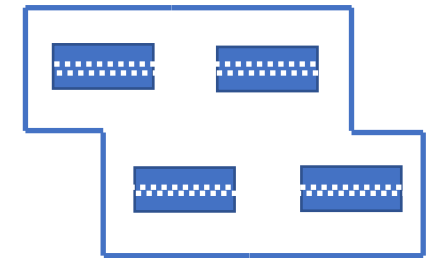
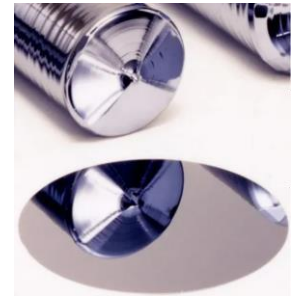

Thermal inkjet

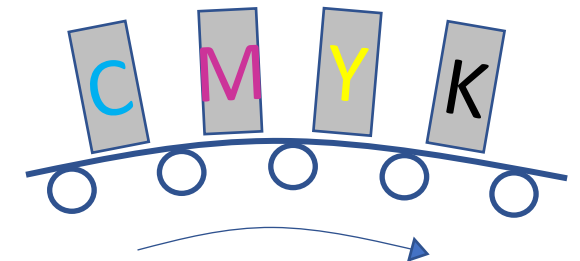

Coverage of a wide range of companies including:

We only review technology developments which we consider to be novel and interesting for in an inkjet technology context. Because of the large number of reviews done over the past 20 years which are in our database, we can more easily justify our selection. Naturally, the big players in the inkjet industry are covered most frequently, however, the choice of patents reviewed is always on the basis of technology rather than on a company basis which means interesting inventions that describe useful technology steps can come from a wide range of companies. We believe our subscribers benefit from this approach and the learning that is gained from the reviews. We try our best to ensure the key inventive steps are clearly explained and with good background given in the introduction of each review. Over time **Directions** can become a valuable library and reference for anyone interested in tracking technology developments in the inkjet industry. In other words it is not possible to review every company in one issue but over the period of just one year an interesting cross section of the inkjet industry which is representative of key developments is provided.



Content of Directions: Recent Examples

Directions issue cover page: Highlights

Highlights:

- Flextensional actuators from Ricoh, Memjet, and others (for context)
- Xaar's higher range and versatility interdigitated electrode actuators
- Edgeband & profiled strip printers from Franz Neuhof and Fritz Egger
- DIC's longer lifetime degasser with slower increase of flow resistance
- A robust way to print impermeable media with aqueous inks from Agfa
- Cypris Materials' novel structured polymer approach to coloured inks
- Better image optical density via Sihl's sublimation dye transfer medium
- Canon's control of gloss using fluorescent inks

Directions issue Table of Contents

Circulation only permitted within subscriber company

DIRECTIONS

Pivotal inkjet resources

TABLE OF CONTENTS

RESEARCH AND DEVELOPMENT ARTICLES.....2

INDUSTRY NEWS.....3

PATENT REVIEW AND COMMENTARY5

PRINthead TECHNOLOGIES.....5

 THERMAL INKJET.....5

 PIEZO INKJET.....7

 MISCELLANEOUS INKJET.....10

 SYSTEM DESIGN.....17

 PRODUCT DESIGN AND APPLICATIONS.....23

INKJET INKS.....29

INKJET SUBSTRATES, COATINGS & 3D BUILD MATERIALS.....35

INDEX OF INKJET APPLICATIONS PUBLISHED JULY/AUGUST 2022 45

How new inkjet
printhead designs work

How new inkjet printers
component designs work

The following slides show excerpts from the main review in a given section of Directions in each case, with examples chosen to illustrate the breadth of coverage

Example 1. Mycronic AB

Patent review excerpt from a review on a silver inkjet paste jetting device

“Previous devices used for dispensing silver paste have used a piezo piston incorporated into the upper part of a cylindrical pump chamber with a nozzle at the end. At the nozzle end there is a paste feed line into the side of the chamber which is controlled by way of a screw pump with a micro-stepper. A piezo piston actuator can, in such a configuration, in principle be operated at up to about 1kHz to cause a pressure change at the nozzle which forces a drop to be ejected.

The patents here seek to improve the control of the drop formation by adding an additional energy stimulus directly at the nozzle where drop formation occurs. Three different approaches to improve drop formation control at the nozzle are discussed here. Apart from improved control, these methods are envisaged to also improve reliability of device operation when printing and reduce the number of interventions required for maintenance.

The figure top right shows a silver paste jetting device without any energy emitter, and is a cross section of the long axis of the jetting assembly. Jetting assembly enclosure 15, PZT actuator stack 21, plunger 23, plunger bushing 25, viscous fluid supply 430 and supply channel 37 are shown, together with portions of the ejection chamber 28, including internal cavity 412 and nozzle cavity 414, nozzle 26, nozzle exit 27, programmable control device 700, and ejecting drop 524.

The figure bottom right shows a laser emitter 550 and laser beam 552 external to the nozzle. An energy stimulus at the nozzle can be used for additional fine adjustment of drop formation on top of the basic piston-based arrangement. Laser-based heating in a region close to the nozzle exit causes localised heating, effectively reducing the paste viscosity making drop break-off easier and more controllable.”

WO 2019/011672 A1 – Jetting devices with energy output devices and methods of controlling the same – Mycronic AB

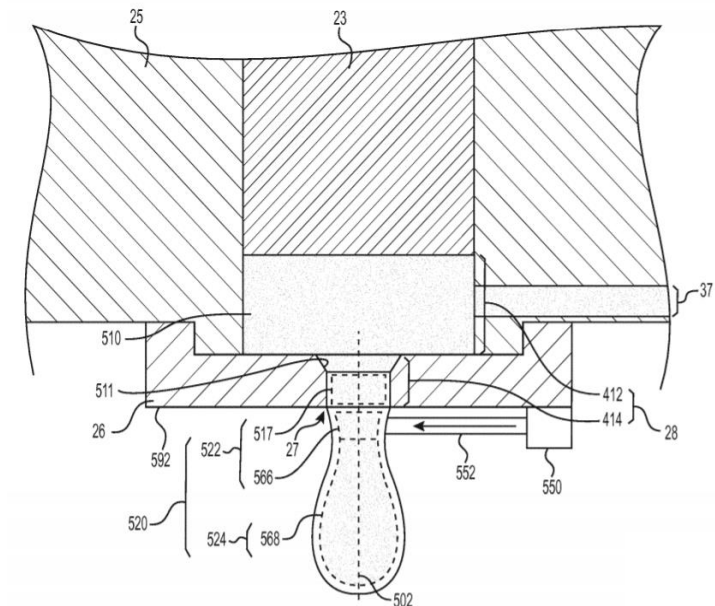
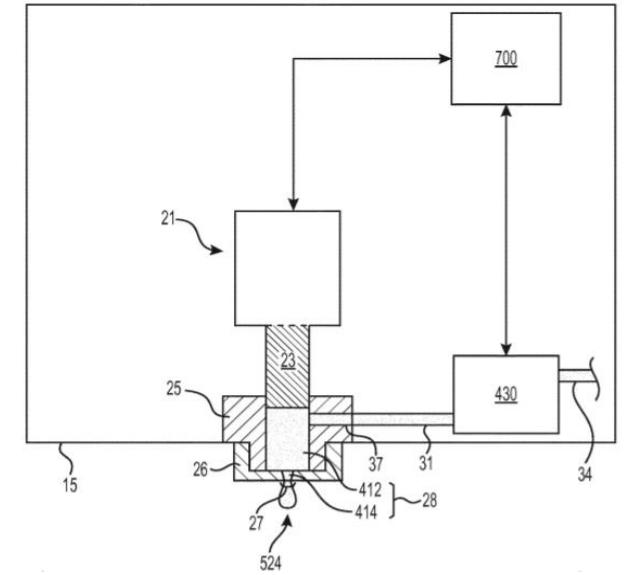

Example 2. Sun Chemical Corp

Patent review excerpt from a review on ebeam-curable inkjet inks

“For a range of reasons often discussed here, UV-curable ink jet inks most often use acrylates as the reactive groups of choice. The energy of a typical UV photon, particularly in the UVA and UVB regions of the UV spectrum, is below the bond energy of the double bond of the acrylate group and so curing in these systems requires the presence of photoinitiators. The energy of electron beam (eb) electrons exceeds the acrylate bond energy and so can be used to directly initiate the free-radical cure mechanism in acrylate ink jet inks.

The removal of photoinitiators has multiple advantages for ink jet inks, as they are often included at significant levels in order to overcome oxygen inhibition. Additionally, if the UV-curable formulation is meant for food packaging then care must be taken to ensure the photoinitiator residues are non-migratable, usually by increasing the molecular weight of the molecules. Thus by using an eb curing mechanism the curable ink jet ink is immediately more suitable for food packaging.

This patent runs with this advantage by formulating food packing inks with little or even no mono function monomers as these materials, after the photoinitiator, are generally the next most problematic materials with respect to migration. Multiple reactive groups have a significantly higher chance of being permanently incorporated into the cured network. However, with UV-curable ink jet inks, reducing the amount of monofunctional monomers often reduces adhesion on non-porous substrates as the shrinkage of the thick (around 10 microns) cured ink layer will be increased. this shrinkage pre-stresses the interface between the ink and the media, a bond that is generally low on such low cost food packaging substrates.

Thus, it is common practice in flexible UV-curable ink jet inks to use blends of monofunctional monomers such as n-vinyl caprolactam or ethylene glycol phenyl ether to promote adhesion to plastic substrates. Other than a reduction in shrinkage, the adhesion improvement with these specific monomers is assumed to arise from their high solvency power for the plastic substrates, allowing the film to key into the surface. this patent also suggests that the adhesion improvements of these monomers is also due to the residual monomers left in the films after cure, plasticising the ink jet film.

This patent considers the challenge of improving the adhesion of high functionality ink jet inks to packaging materials, with a focus on ensuring minimal migration of monomers from the final cured film.

The best performing exemplified formulation uses only difunctional monomers and higher, such as dipropylene glycol diacrylate (DPGDa), 2-(2-vinyloxyethoxy)ethylacrylate, 3-methyl-1,5-pentanediol diacrylate and an ethoxylated trimethylolpropane triacrylate. To this monomer mix was added a surfactant, a pigment and 0.5 wt% Irgacure 815 to give an ink jet ink with a viscosity of 10 cps at 45 C, that fully passed adhesion testing on a polyester substrate when cured at an eb dose of 50 kGy. Total extractable monomers or photoinitiator were less than 20 ppb for this ink and cure dose.”

WO 2017/180491 A1 – Electron beam curable inkjet formulation with improved adhesion – Sun Chemical Corp

Example 3. Hewlett-Packard Development Co, LP

Patent review excerpt from a review on inkjet-based 3D printing of conductive tracks

“This patent describes a materials set for printing embedded electrical traces within a 3D printed part using the HP Inkjet Fusion printer. The basis for this printer is a thermoplastic polymer such as nylon which will have a melting point between 70 and 350°C. A powder bed with a particle size of 20 to 200 μm is printed with a fusion agent that acts as a thermal energy absorber, generally containing carbon black which acts as an energy absorber. On exposure to an IR or halogen-based heating lamp, the energy is transferred to the polymer, which in turn fuses to create a solid in the areas where fusion agent has been printed. Subsequently, a fresh layer of powder is spread over the printed and fused layer and the next layer of the image is printed.

Both figures on the right show cross-sectional views through the powder bed with conductive material printed on the righthand side and nonconductive materials on the left.

The top image illustrates the powder prior to fusing while the figure on the bottom shows it after fusing. In the top image thermoplastic particles 230 are shown printed with bronze particles 250 and nanometal particles 220. In the bottom image is shown the composite materials consisting of a fused thermoplastic matrix 330 with domains of sintered bronze 250 and metal 320 nanoparticles. In each case the sintered particulate domain will be interconnecting to form continuous conducting or non-conducting tracks through the fused part. The amount of conductive ink printed can be varied to give tracks with different conductivities in the x-y plane, and larger quantities of ink can be printed to form vias between the planes.”

WO 2018/080438 A1 – Material sets – Hewlett-Packard Development Co, LP

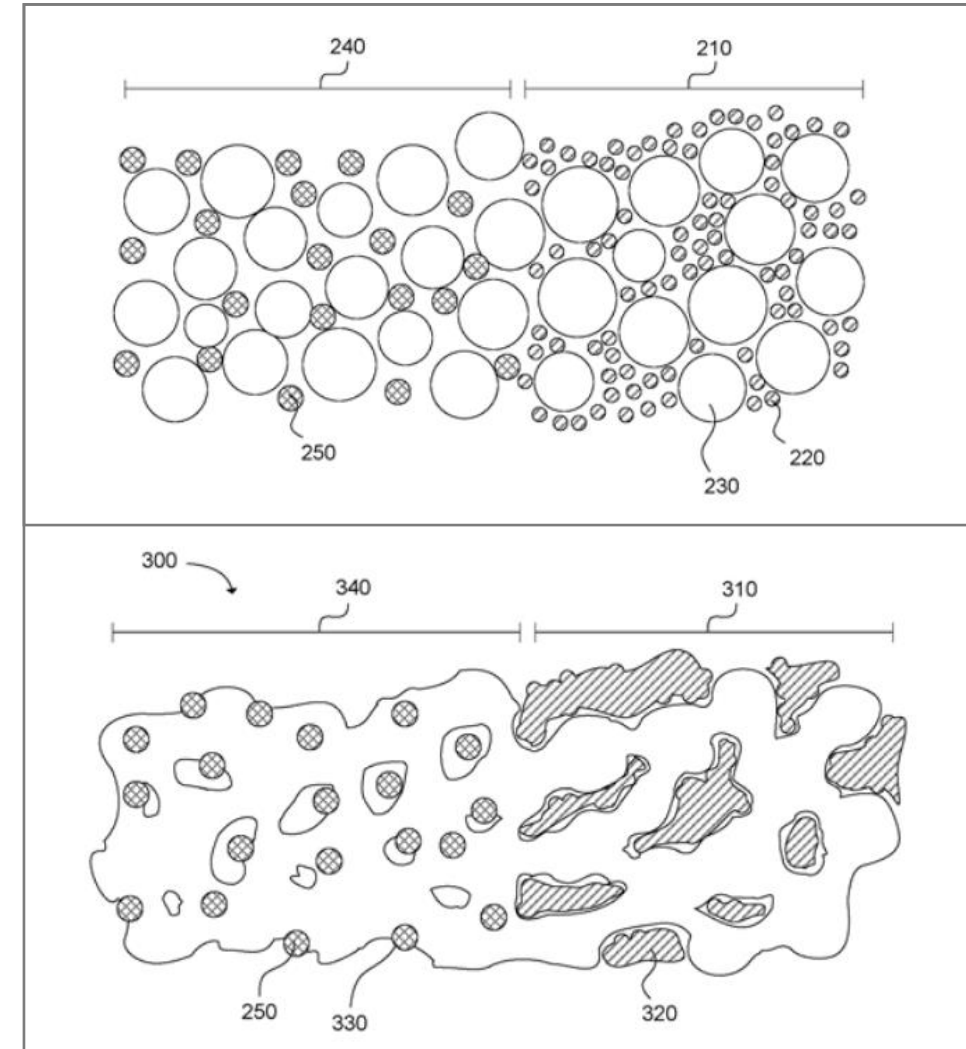

Example 4. LG Chem Ltd

Patent review excerpt from a review on inkjet-printed OLED encapsulation materials

“In the device schematic shown top right, the OLED core components 32 have a sealing structure 36 (not discussed in the patent), followed by the organic encapsulation layer 37 (which is discussed in these patents) and finally a cover substrate 38. The required properties for this encapsulation layer, other than having physical properties suitable for ink jet printheads, are good adhesion, an ability to efficiently planarize the device surface, and low levels of outgassing of volatiles after cure. This latter point is critically important, as any water, or, oxygen contamination of the ink would cause device failure. As these inks are deposited in controlled environments and, due to the potential for water contamination, the patents insist that the inks must be free from volatile components. This adds further complexity to the formulation if it is to remain ink jet printable. Consequently, a 100% solids UV-curable approach has been chosen.

As discussed, the inks must have zero oxygen content, rendering a free-radical, curable acrylate approach problematic, due to poor long-term stability issues. The patent has, therefore, focused on a cationic chemistry, using a mixture of a cycloaliphatic epoxies, an oxitane and a vinyl ether material to keep the viscosity to a sensible level.

The most successful formulations are comprised of limonene dioxide (10wt%), Celloxide 2021P (10wt%), 1,4-cyclohexane dimethanol divinylether (55wt%) and the oxetane OXT-221 (17wt%). These ink formulation structures are shown bottom right.

The formulation was printed using a Unijet UJ-200 using a 10pl Dimatix 256-nozzle printhead onto the substrate and allowed to planarize for forty seconds before illuminating with Uv radiation at an intensity of 1000mJ/cm² at 395nm. Adhesion of the cured film was good and devices built using the technology appears to offer significant improvements over the comparative technologies.”

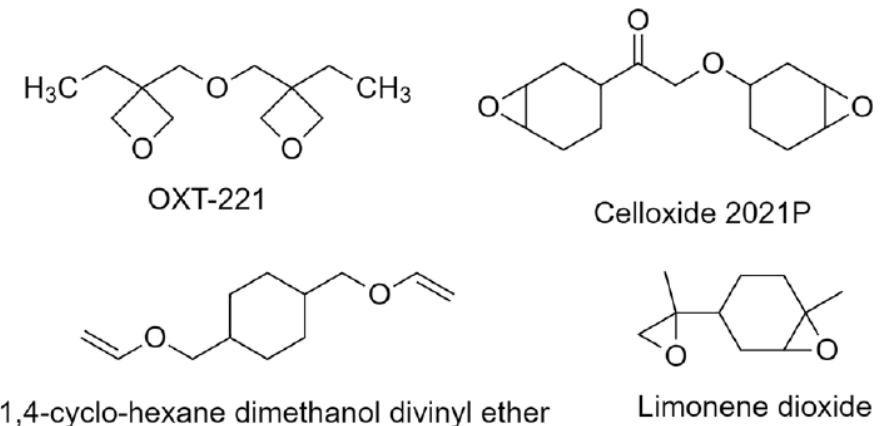
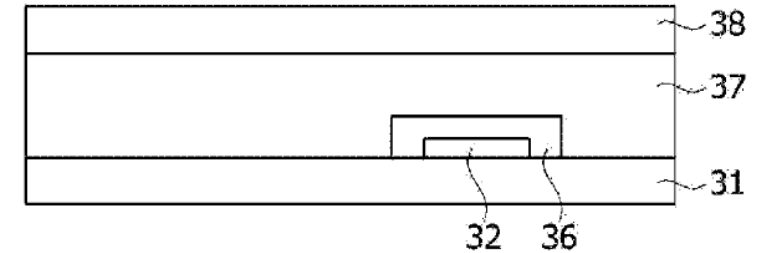

US2020/0095456 A1 – Encapsulating composition – LG Chem Ltd

Example 5. Fujifilm Dimatix, Inc.

Patent review excerpt from a review on an industrial Si-MEMS piezo inkjet printhead

“Silicon mems printheads can be manufactured with a high density of actuator chambers, allowing high-resolution single pass printheads to be developed. However the small dimensions of the actuator chambers require thin-film piezo actuators to be used, and together these have limits to the amount of displacement, and hence pressures and drop sizes that can be generated. This patent application proposes a way to overcome this, allowing larger drop volumes to be generated from the same size actuator and at a similar voltage.

The improvement is achieved by forming trenches in the piezo layer. Here the actuator 108 is formed on the surface of a membrane 102 over the actuator chamber 104. the trenches 110 allow the piezo layer to flex to a greater extent, resulting in more displacement of the membrane for the same applied voltage.

In the image bottom right, flexing is shown in more detail. as shown in the inset, a trench 1008 has been formed through the piezo material 1002. The actuator, therefore, flexes around the trench as shown. The piezo layer is 2-5 microns thick, over a silicon or semiconductor membrane. As well as the trench acting like a hinge, the stresses that would otherwise occur within the piezo layer are reduced.”

WO 2018/118774 A1 – Actuators for fluid delivery systems – Fujifilm Dimatix, Inc.

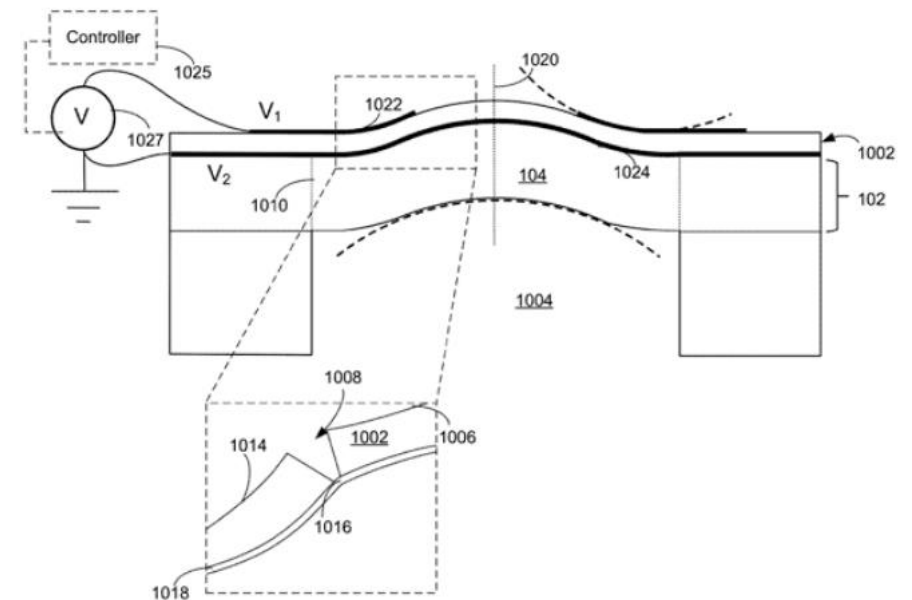
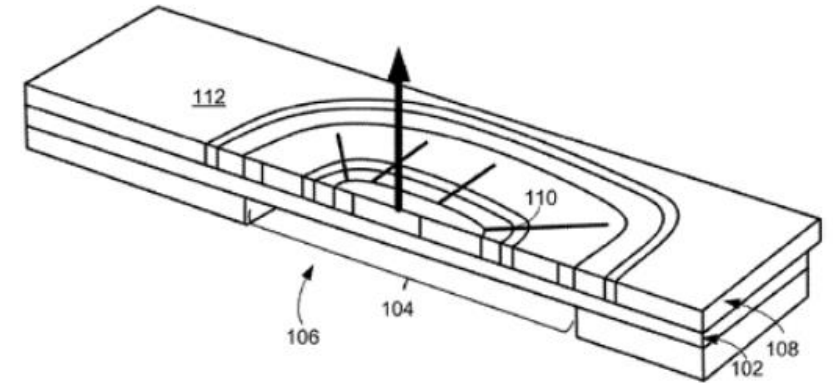

Example 6. Tetra Laval Holdings and Finance

Patent review excerpt from a review on an inkjet printer for packaging

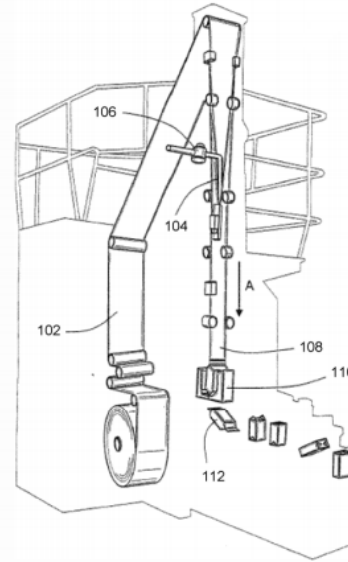
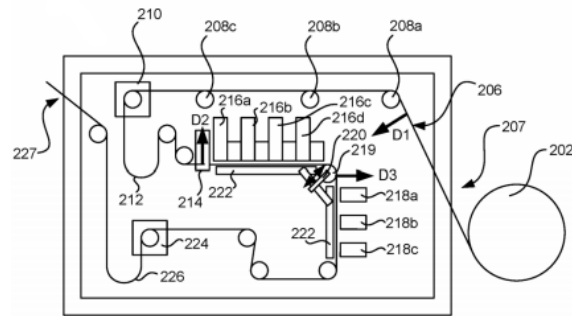

On the far left is a side view of the digital carton printer with web 202, printbars 216 and UV ink curing lamps 218 with a metal UV light shield 222. By redirecting the web twice using web feeding assembly (208a, 208b, 208c, 210, 219, 224), the carton packaging material can be supplied in the same manner as done today (on a reel 202 with what will be the inner surface 206 of the carton facing outwards and with the laminated surface facing inwards).

Changing business model: today printing for packaging like this is done off site by converters using flexo presses; an inkjet printer at the packaging site would be advantageous to meet the growth in demand for short-run packaging print jobs. Patents like this from large companies that are dominant in their sector are a strong indication of future technology directions.

WO 2020/229246 A1 – An apparatus for digital printing of carton-based packaging material for packages holding liquid food products and a method thereof – Tetra Laval Holdings & Finance

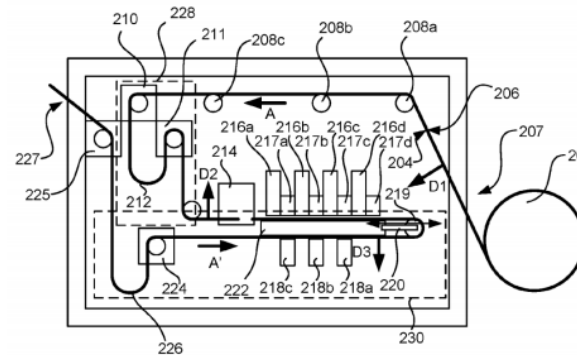

Another digital printer configuration is shown on the left using pinning lamps 217 beside each printbar. In this space-saving configuration the curing lamps 218 are beneath the printbars, separated by metal UV shielding plate 222.

The general approaches used in both printer configurations discussed can also be used for non-liquid food products, such as potato crisps.

Further, the packaging material may pass through a sterilization device, e.g. a hydrogen peroxide bath or an LVEB (Low-Voltage Electron Beam) station. In principle, if an Ebeam source was used, it could be positioned after the ink jet printing station and both cure a food-safe Ebeam ink as well as sterilize the printed medium prior to direct entry into the filling machine.

Sample excerpts describing the patent index

Table of Contents

Circulation only permitted within subscriber company

DIRECTIONS

Pivotal inkjet resources

INDEX OF INKJET APPLICATIONS PUBLISHED JULY/AUGUST 2021

Bold type indicates review in this issue

Reference key: **H** Printheads/Hardware **I** ink **M** Inkjet substrates, coatings & 3D build materials

Month	Ref	Publication No.	Assignee	Title
Jan-21	H	EP 3 758 943 A1	3C Project Man Limited	Droplet ejector
Jul-21	M	WO 2021 150854 A1	3D Systems Inc	Water soluble waxy support materials for three-dimensional printing applications
Jul-21	M	WO 2021 150863 A1	3D Systems Inc	Waxy build materials for three-dimensional printing applications
Jul-21	M	US2021 0230439 A1	3D Systems Inc.	Waxy build materials for three-dimensional printing applications
Jul-21	M	US2021 0198479 A1	3M Innovative Properties Co	Graphic articles comprising polylactic acid polymer based film
Jul-21	M	US2021 0214575 A1	3M Innovative Properties Co	Ink-receptive layers for durable labels
Aug-21	M	US2021 0260891 A1	3M Innovative Properties Co	Edge detackification and decoration of adhesive tape rolls
Aug-21	M	US2021 0261828 A1	3M Innovative Properties Co	High density post arrays
Aug-21	M	WO 2021 156713 A1	3M Innovative Properties Co	Curable compositions for forming light scattering layers
Aug-21	H	WO 2021 168166 A1	Acelorex Inc	System and process for printing on objects
Aug-21	H	WO 2021 156785 A1	Advanced Vision Tech AVT Ltd	Method, system and patterns for aligning print-heads in a digital printing press

An inkjet technology patent index section is included as an add-on section to the core patent review section in **Directions 'V2'** options (see next slide for pricing).

- In Directions 'V2' options, an index appears as approx. 20 additional A4 pages (typically 500-600 entries/issue) at the end of the patent reviews .pdf
- Examples of the heading for the index section (above left), and of the tabulated .pdf format index (above right) are shown on this slide.

Directions 'V2' product options:

- The index is published and sorted alphabetically by company name
- For each company, all European (EPA), USA and World (PCT) patents are grouped
- Lines in bold text above indicate the patents reviewed in that issue of Directions
- In the Ref or 'reference' column, 'H' is for hardware, 'I' is for ink, 'M' is for media
- An excel spreadsheet version of the index is also provided (emailed concurrently with the .pdf file) and is shown on the next slide.

Subscription Options to Directions

2023 – 2024 Annual Subscription Pricing →

Join any time!







6 issues of Directions
(1 year's worth) will always be
received.

.pdf files

V2-X includes a cumulative .xls
patent index spreadsheet listing
all inkjet patents recorded by
i4inkjet Ltd. over the period of
the subscription

For more info about Directions
or the Inkjet Market Report,
please email
mikala@i4inkjet.com

For subscription pricing in US
dollars, please email
al@imiconf.com, our partner at
[IMI USA](#)

Product Options (click for details)	Annual Subscription Cost	Single- or Multi-Site Use	Patent Index (PDF)	Patent Index (Excel)	Patent Reviews	Industry News	R&D Articles
	€						
Dir' V1-S	3900	Single site	Not included	Not included	Included	Included	Included
Dir' V1-M	4900	Multiple sites	Not included	Not included	Included	Included	Included
Dir' V2-S	5700	Single site	Included	Included	Included	Included	Included
Dir' V2-M	6900	Multiple sites	Included	Included	Included	Included	Included
Inkjet Market Report	4500	–	–	–	–	–	–
Bundle Deals	Contact Us	–	–	–	–	–	–

Section descriptions included in Directions Inkjet Patent Reviews:

Index of inkjet-related
patents
A list of searched and found
recently published European,
US, and global (PCT) patent
applications of inkjet
technologies.

20 novel inkjet patent
reviews (see below)
Reviews of 20 key novel inkjet-
related patent applications
(split into categories listed
below), picked and reviewed by
our inkjet experts.

Latest inkjet industry and
market news
An update of the latest
industry news from the world
of inkjet.

Inkjet research &
development articles
Selected articles from
academic publications about
inkjet technologies.

Directions Celebratory Special Offer !!

To celebrate our new website and rebranding of Directions Inkjet Patent Reviews, we are offering new and recurring customers some special deals:



New customers:

If you subscribe as a new customer in 2024 for the current annual series (2023 series) of Directions, you receive 2020 FREE OF CHARGE!

Recurring customers:

In 2025 first time subscribers and repeat subscribers from 2024 will receive the 2021 series free as well as a new 6 issue year long subscription to Directions. This is intended to help new subscribers to build an inkjet library quickly and cost effectively!

Please contact mikala@i4inkjet.com for more information.



More from i4inkjet

Pivotal Inkjet Resources

pivotal
inkjet resources

from

i4inkjet

‘Pivotal inkjet resources’ is the consultancy part of i4inkjet Ltd.

Examples of recent consultancy project categories include the following:

- **Customised patent searches** (in support of due diligence, and FTO work for companies)
- **Inkjet technology reviews** (printhead design and how it is evolving)
- **Inkjet market information** (reviews on a chosen industry sector or segment (e.g. packaging/labels))
- **Inkjet strategy consulting** (getting the most out of inkjet for your business, ideation, leveraging inkjet information provided and at your disposal most effectively)
- **Inkjet training days** (online or on-site training available)

For more information, to arrange an online call or in-person meeting at an upcoming event, please use the contact form provided on the i4inkjet Ltd.

Market research report available from i4inkjet Ltd.

i4inkjet Limited is official distributor in Europe and the US for DataSupply Inc's inkjet market report, enabling you to get your technical inkjet content and marketing inkjet content from the same source. Email adam@i4inkjet.com for more info.



Multi-Client Study

[2022 version of Inkjet Printing Market Forecast]

"The Latest Market Data for Inkjet Technology Adoption and its Significance to Transforming Manufacturing Sectors"

=Comprehensive analysis of the commercial and industrial inkjet market (hardware, ink, and printheads)=



Kornit's Presto MAX is leading the pigment textile printing market



Konica Minolta's presence grows in the commercial printing press market

€4500



EFT's Nozomi C14000 LED single-pass press for the corrugated printing market



December 2022
Data Supply Inc.

Markets covered in detail in this report (published in December 2022) include textiles, labels & packaging, coding & marking, commercial printing, transactional printing, graphics & technical, signage, and ceramics

B-3. Textile market99

1. Overall shipment value (hardware machines and inks from 2018 to 2024)99

2. Market overview (digital ratio and inkjet ratio)100

3. Market share of sales of textile business by inkjet maker (2020)101

4. Shipment trend by type of hardware machines (DTF/sublimation transfer/DTG from 2018 to 2024)102

4-1. Overall102

1) Shipment volume102

2) Shipment value103

4-2. Shipment trend of digital textile printers (DTF and sublimation transfer) by speed segment ...104

1) Shipment volume104

2) Shipment value105

3) Market share by maker (2020)106

(1) Market share of shipment volume of large digital textile printers (DTF/sublimation transfer) ...106

(2) Market share of shipment volume of small sublimation transfer printers107

4-3. Shipment trend of DTG108

1) Shipment volume108

2) Shipment value109

3) Market share of shipment volume by maker (2020)110

① DTG (for mass production)110

② DTG (desktop)110

5. Shipment trend of inks by type (2018-2024)111

5-1. Shipment trend of inks by type of hardware machines111

1) Shipment volume111

2) Shipment value112

5-2. Shipment trend by type of inks (reactive/dispersion/acid/sublimation transfer/pigment) ...113

1) Shipment volume113

2) Shipment value114

3) Market share of shipment volume by maker (2020)115

① DTF ink115

② Sublimation transfer ink116

4) Trend of ink technology117

5) Trend of ink price119

6. Trend of printhead applications119

7. Summary of major makers120

7-1. Major DTF printer makers120

1) Japanese makers
Konica Minolta/Epson (Robustelli)/Mimaki Engineering (La Meccanica)/Toshin Kogyo/Seiren

2) European and US makers
MS Printing Solutions (Dover Group)/Reggiani(EFD)/Aleph/Durst

3) Chinese makes
Atexco/HOMER/Hopetech/Others

7-2. Major sublimation transfer printer makers122

1) Japanese makers
Epson/Mimaki Engineering/Others

2) Chinese makers
Human Digital Technology (Shanghai)/Shanghai ALLWIN Digital Technology

7-3. Major DTG printer makers123

1) Japanese makers
Epson/Brother Industries/Ricoh (AnaJet)/Others

2) European and US makers
Kornit Digital/Others

3) Chinese makers
CNTOP/Nocai

8. List of major machines of each company (49 companies)125

8-1. DTF/sublimation transfer (31 companies)125

8-2. DTG (18 companies)131

The index above is an excerpt from the main TOC which relates to the section of the report covering the textile market

Avail of our excellent value bundle deals including technical content from Directions and the market report above

Thank you for taking the time to read our slides

Directions inkjet patent reviews

produced by

i4inkjet



To get in touch about ordering **Directions**, please email mikala@i4inkjet.com

Reminder: i4inkjet Ltd. will be attending these 2023 trade shows:

